



02/4

	<p align="center"><b>RESEARCH DEVELOPMENT AND TESTING NATIONAL INSTITUTE FOR ELECTRICAL ENGINEERING I C M E T C R A I O V A</b></p>	<p align="center">acreditat pentru ÎNCERCARE</p>  <p align="center">SR EN ISO/CEI 17025:2005 CERTIFICAT DE ACREDITARE nr. LI 450/2010</p>
<p align="center"><b>DEPARTMENT LABORATORIES High Voltage Division - HVD High Voltage Laboratory and Electromagnetic Compatibility HVL - EMC</b></p>		

Bvd. Decebal No.118A, 200746 Craiova, ROMÂNIA  
Phone: + 40 0351 402425, 404888; Fax: + 40 0351 404890  
[www.icmet.ro](http://www.icmet.ro), e-mail: [market@icmet.ro](mailto:market@icmet.ro)

## TEST REPORT

### No. 43937 / 26.09.2013

1. **CUSTOMER: SCHIRTEC AG**  
Ignaz – Köck Strasse 10, A-1210 Wien, Austria
2. **MANUFACTURER: SCHIRTEC AG**  
Ignaz – Köck Strasse 10, A-1210 Wien, Austria
3. **TESTED PRODUCT: Early Streamer Emission (E.S.E.) Lightning Conductor type  
SCHIRTEC – AM (S-AM)  
Prototype**
4. **REFERENCE STANDARD: NFC 17-102 : 2011, Annex C  
UNE 21186 :2011, Anexo C**
5. **TEST PERFORMED:** Determination of the E.S.E. lightning conductor efficiency
6. **TEST DATE:** 16.09.2013
7. **TEST RESULTS:** There are presented the measurements results.
8. The report contains: 14 pages.
9. The test report is edited in 4 copies, copy no.1 remain in laboratory and copies 2, 3 and 4 are sent to the customer.

**HEAD OF HV DIVISION**  
Eng. PĂTRU Ion  

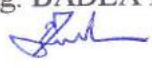
**HEAD OF HV LABORATORY**  
Eng. BADEA Ion  

1. Results refer to the tested product only.
2. Publication or reproduction of the contents of this report in any other form unless its complete photocopying is not allowed without writing approval of Division to which laboratory belongs.
3. All signatures of the present report are original ones.



HVD

Content	page
➤ Identification of the test product.....	3
➤ Test program.....	3
➤ Responsible for test .....	3
➤ Opinions and interpretations (if necessary).....	3
➤ Present at the test .....	3
➤ Tested material.....	4
➤ Type of tests .....	4
➤ Specification.....	3
➤ Test equipments.....	4
➤ Test circuit.....	4
➤ Mounting arrangement.....	5
➤ Test procedure.....	5
➤ Test on S.R.L.C.....	6
➤ Test on E.S.E.L.C. type SCHIRTEC-AM (S-AM).....	7
➤ Table with values of break-down times for S.R. Lightning Conductor .....	8
➤ Table with values of break-down times for E.S.E. Lightning Conductor type SCHIRTEC- AM (S-AM).....	9
➤ Graphic determination of the E.S.E.L.C. efficiency.....	10
➤ Test circuit diagram.....	11
➤ Test set-up for E.S.E.L.C. ....	12
➤ Drawing of E.S.E. Lightning conductor type E.S.E. SCHIRTEC-AM (S-AM).....	13
➤ Photos.....	14



HVD

**1. Identification of the test product:**

**Type:** SCHIRTEC-AM (S-AM)

**Serial / year:** prototype / 2013

**Technical Specification / Drawing:** see page 13

**Contract // Test order:** 8044 / 16.05.2013//-

**Internal test order:** 22160 / 20.05.2013

**Product receiving date:** 12.09.2013

**Product condition at receiving:** New

**2. Test program:** Determination of the E.S.E. lightning conductor efficiency

**3. Responsible for test:** Eng. Mircea BORUZ *BORUZ*

**4. Opinions and interpretations (if necessary):**

**5. Present at the test:**



HVD

### **1. Tested material**

Early Streamer Emission (E.S.E.) Lightning Conductor type SCHIRTEC-AM (S-AM).

See drawing from page 13 and photos from page 14.

### **2. Type of test**

A switching impulse wave having negative polarity and a DC voltage also of negative polarity were applied on the upper metallic plane.

### **3. Specification**

NFC 17-102 / 2011 Annex C

UNE 21186 : 2011, Anexo C

### **4. Test equipments**

Laboratory inner dimensions: 48 m x 32 m x 27 m (height)

Altitude: 100 m above sea level

4200 kV High Voltage Impulse Generator type SPF 340; 340 kWs,  
TUR Dresden – Germany with its own 4200 kV capacitive divider

1000 kV Rectifier cascade type GS 1000 / 30; 30 mA; TUR Dresden – Germany

1400 kV Damped RC divider, ICMET Craiova, Romania;

TR – AS Transient – Recorder, Dr. Strauss System Elektronik, GmbH – Germany

Digital multimeter Keithley, serial no. 1070037 – USA.

### **5. Test circuit**

See the test circuit diagram from page 11.

The measuring system consists of:

- 1400 kV measuring system that consists of damped RC divider, transient recorder, TR-AS 100-10/4 and measuring cable having Calibration Certificate no. 278 DKD – K – 8701 / 12.2011;
- DC measuring system that consists of DC resistive divider, digital multimeter type Keithley and measuring cable having Calibration Certificate no. 211 / 2010 – 06 DKD – K – 18701.

Expanded uncertainty of the measuring system is inside the limits prescribed by IEC 60060 – 2 / 2010 for SI Approved Measuring Systems (3 % for peak values and 10 % for time parameters).





HVD

## 6. Mounting arrangement

See the test set up from page 11 and 12.

See photos from the page 14.

The tested E.S.E. Lightning Conductor was set on a 5 x 5 m grounded metallic plane and connected to ground.

A square metallic plane with dimensions: 4.5 m / 4.5 m / 0.2 m having the edges rounded, was suspended above the lightning conductor and connected to high voltage.

## 7. Test procedure

The DC polarization voltage was applied on an upper square metallic plane.

The negative impulse wave was adjusted in order to obtain a flashover.

The height of the lightning conductor (h) and the distance between the ground and the square plane (H) were measured at the beginning of each test.

The atmospheric conditions were taken at beginning, at middle and at the end of each test.

The peak value ( $U_p$ ) of the impulses and the triggering time ( $T_B$ ) were recorded for each impulse.

Fifty significant impulses were applied on each lightning conductors S.R.L.C. and E.S.E.L.C.

The Early Streamer Emission Lightning Conductor (E.S.E.L.C.) was compared with a Simple Rod Lightning Conductor (S.R.L.C.).

The test was performed in the same conditions and configuration for each lightning conductor: E.S.E.L.C. and S.R.L.C.

- Height of lightning conductor (h) adjusted to: 1182 mm;
- Distance between ground / square plane (H) adjusted to: 2445 mm;
- h / H: 0.483;
- Polarization voltage: 53.9 kV;
- Peak time / Rise time of the full wave: 293.6  $\mu$ s / 230  $\mu$ s;
- Time interval between consecutive impulses:  $\geq 2$  min.



## 8. Test on S.R. Lightning Conductor

8.1. Test date: 16.09.2013

8.2. Atmospheric conditions

BEFORE TEST	p = 996 mb t = 19.4 °C hr = 48.2 %
MIDDLE OF THE TEST	p = 996 mb t = 19.8 °C hr = 47 %
END OF THE TEST	p = 996 mb t = 20 °C hr = 46.3 %

8.3. Results

See tables from page 8

Number of significant impulses: 50

Average of significant  $T_B$  (break-down times) calculated from the experimental results is  $T_{SRLC} = 190.75 \mu s$  with a standard deviation  $\sigma_{SRLC} = 20.35 \%$ .

By transferring  $T_{SRLC}$  on the reference waveform it was obtained  $T'_{SRLC} = 388.22 \mu s$

See curves from page 10



HVD

## 9. Test on E.S.E. Lightning Conductor type: SCHIRTEC-AM (S-AM)

9.1. Reception date: 12.09.2013

9.2. Test date: 16.09.2013

9.3. Atmospheric conditions

BEFORE TEST	p = 996 mb t = 20.1 °C hr = 46.4 %
MIDDLE OF THE TEST	p = 995 mb t = 20.4 °C hr = 46.4 %
END OF THE TEST	p = 994 mb t = 20.6 °C hr = 46.2 %

9.4. Results

See tables from page 9

Number of significant impulses: 50

Average of significant  $T_B$  (break-down times) calculated from the experimental results is  $T_{ESEL C} = 180.02 \mu s$  with a standard deviation  $\sigma_{ESEL C} = 14.17 \%$ .

By transferring  $T_{ESEL C}$  on the reference waveform it was obtained  $T'_{ESEL C} = 370.31 \mu s$

See curves from page 10

*Measuring uncertainty for  $\Delta T$  is 5.7 %.*

*The uncertainty stated is expanded uncertainty obtained by multiplying the standard uncertainty by the coverage factor  $k = 2$ . The value of measurand lies within the assigned range of values with probability of 95 %.*

Early streamer emission:  $\Delta T = T'_{SRLC} - T'_{ESEL C} = 388.22 - 370.31 = 17.91 \mu s \pm 1.02 \mu s$

The tested lightning conductor is an ESEAT (early streamer emission air terminal) because it fulfils the following conditions (according to NFC 17-102 / 2011, Annex C, clause C.3.5.2.5):

- $T_{ESEL C} < T_{SRLC}$  ( $180.02 < 190.75$ );
- $\sigma_{ESEL C} < 0.8 \sigma_{SRLC}$  ( $14.13 < 0.8 \cdot 20.35$ );
- $T_{SRLC} - T_{ESEL C} > 10 \mu s$ .



**Table with values of break-down times  
for S.R. Lightning Conductor**

<b>Impulse no.</b>	<b>T<sub>B</sub> [μs]</b>	<b>Impulse no.</b>	<b>T<sub>B</sub> [μs]</b>
1	232.60	26	176.70
2	214.90	27	164.80
3	158.00	28	185.60
4	173.30	29	206.60
5	216.00	30	163.30
6	169.10	31	333.30
7	187.20	32	312.90
8	214.00	33	143.90
9	125.20	34	199.90
10	223.30	35	178.50
11	238.30	36	146.40
12	145.40	37	167.10
13	193.00	38	180.50
14	175.80	39	203.80
15	215.20	40	181.10
16	163.90	41	211.00
17	163.40	42	176.30
18	272.50	43	169.90
19	173.20	44	189.80
20	147.20	45	193.40
21	202.20	46	209.70
22	192.30	47	165.40
23	195.20	48	168.80
24	196.50	49	163.70
25	152.70	50	204.60

- Where T<sub>B</sub> represents the break – down times of the 50 usable impacts.





**Table with values of break-down times  
for E.S.E. Lightning Conductor type SCHIRTEC-AM (S-AM)**

Impulse no.	T <sub>B</sub> [μs]	Impulse no.	T <sub>B</sub> [μs]
1	194.60	26	173.80
2	190.30	27	198.40
3	162.40	28	156.60
4	169.10	29	151.40
5	154.10	30	185.60
6	175.00	31	200.40
7	173.80	32	164.40
8	185.20	33	179.30
9	149.70	34	179.10
10	147.80	35	164.20
11	147.60	36	189.20
12	201.60	37	178.00
13	205.70	38	172.50
14	181.50	39	156.80
15	177.70	40	170.40
16	179.40	41	150.80
17	246.20	42	209.70
18	221.30	43	228.30
19	243.40	44	182.50
20	226.10	45	183.50
21	152.00	46	175.80
22	150.90	47	184.30
23	167.30	48	155.50
24	221.60	49	167.60
25	184.50	50	134.00

- Where T<sub>B</sub> represents the break – down times of the 50 usable impacts.



HVD

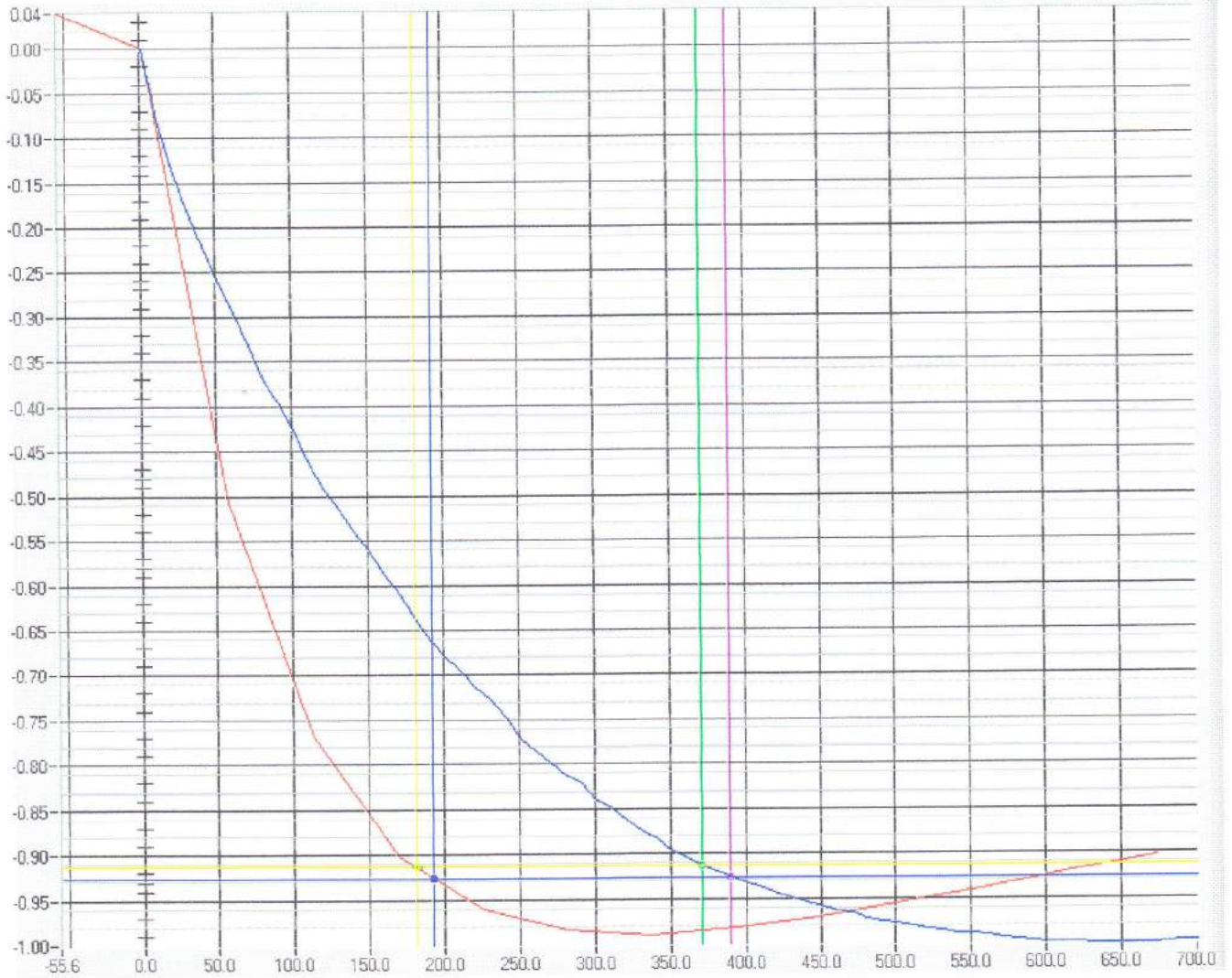

Where:

- On OX axes there is represented time in  $\mu\text{s}$ ;
- On OY axes there is represented amplitude  $U / U_{\text{peak}}$  in relative units;
- Red line is the experimental waveform;
- Blue line represents the standard waveform.

$$T_{\text{SRLC}} = 190.75 \mu\text{s}$$

$$T'_{\text{SRLC}} = 388.22 \mu\text{s}$$

$$T_{\text{ESEL C}} = 180.02 \mu\text{s}$$

$$T'_{\text{ESEL C}} = 370.31 \mu\text{s}$$

$$\Delta T = T'_{\text{SRLC}} - T'_{\text{ESEL C}} = 17.91 \mu\text{s}$$



HVD

Test circuit diagram for testing E.S.E. conductors

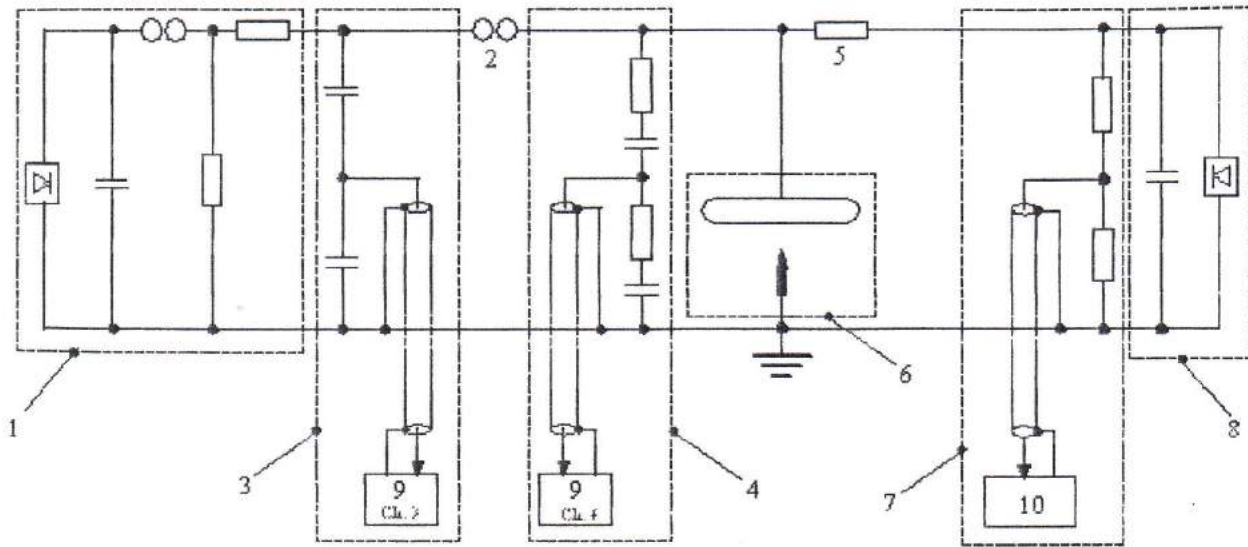

- 1 - HV Impulse Generator 4.2MV -336kWs
- 2 - Serial protective gap,  $\phi=250\text{mm}$
- 3 - 4.2 MV measuring system
- 4 - 1400 kV measuring system
- 5 - Resistance 2M $\Omega$

- 6 - E.S.E. test configuration
- 7 - 1 MV DC measuring system
- 8 - Rectifier DC cascade GS 1000/30
- 9 - Transient recorder TR-AS 100-10/4, channels 3 and 4
- 10 - Digital multimeter KETHLEY serial no.1070037



TEST SET UP ON EARLY STREAMER  
EMISSION LIGHTNING CONDUCTOR

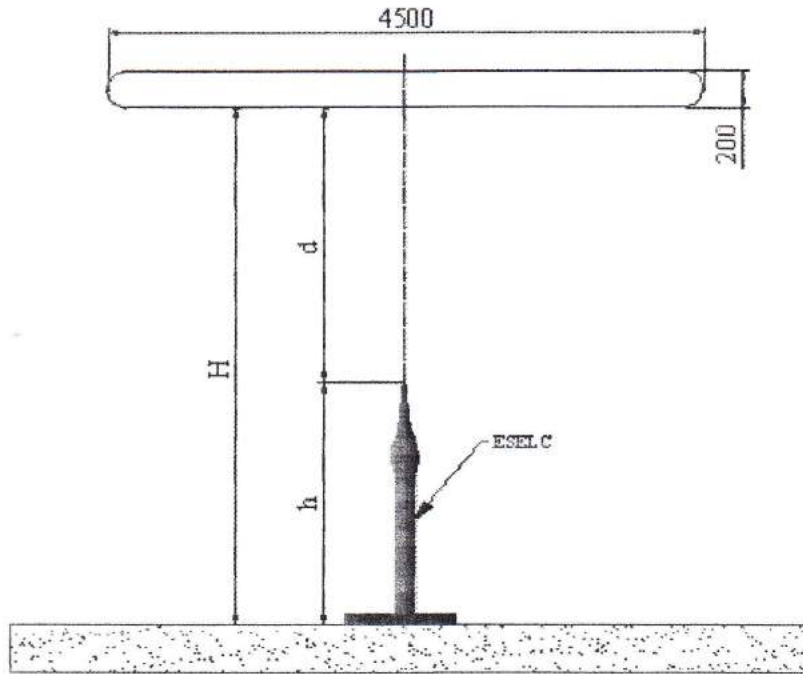





HVD

2 TECHNICAL SPECIFICATIONS 3 4

NO	DESCRIPTION	APPROVAL	DATE

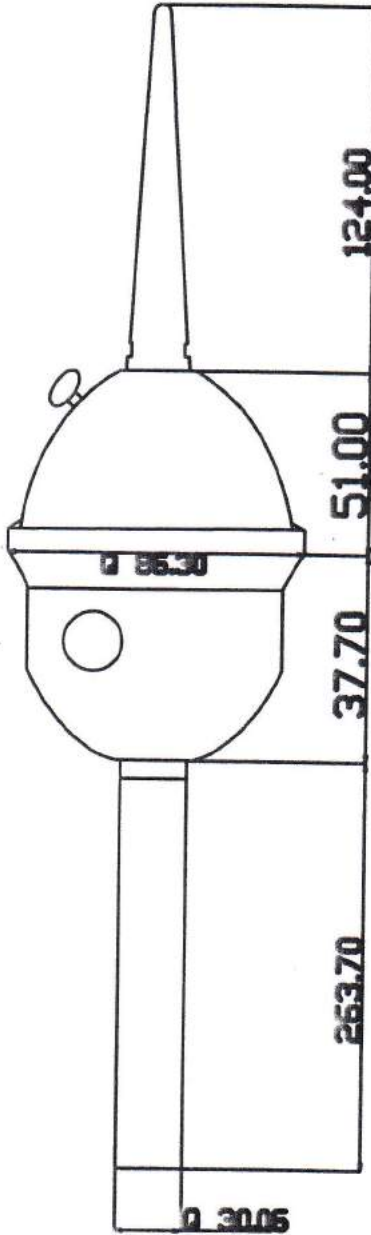

ALL RIGHTS RESERVED, WITHOUT WRITTEN CONSENT, NONE OF THE DETAILS IN THIS DOCUMENT MAY BE COPIED, RECORDED, PRINTED OR DUPLICATED

A  
B  
C  
D  
E  
F  
G

	NAME	DATE	SIGNATURE
PREPARED			
CONTROL			
APPROVAL			
MATERIAL			WEIGHT
STANDARD EQUIPMENT			
COATING			

SCHIRTEC®

S-AM

Code F-01.09.01(e)

\* UNIT OF MEASURE : mm  
 \* TOLERANCES STATED IN PICTURES  
 : MEASURE : ± 0.5... mm / ANGLE : ± 1...'  
 - SURFACE ROUGHNESS : 3.2... µm  
 \*NOT MEASURE ON DRAWING

PART NO/DRAWING NO:

DATE OF PUBL	SCALE	PAGE	SIZE

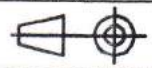



HVD



Photos